

THE PROPERTY OF THE DRAWING IS ESTABLISHED BY LAW. IT IS FORBIDDEN TO PRODUCE OR SHOW IT TO THIRD PART. WITHOUT A WRITTEN AGREEMENT.

Item	Name	Q.ty
1	CA.08.09.017	1
2	CA.08.28.009	1

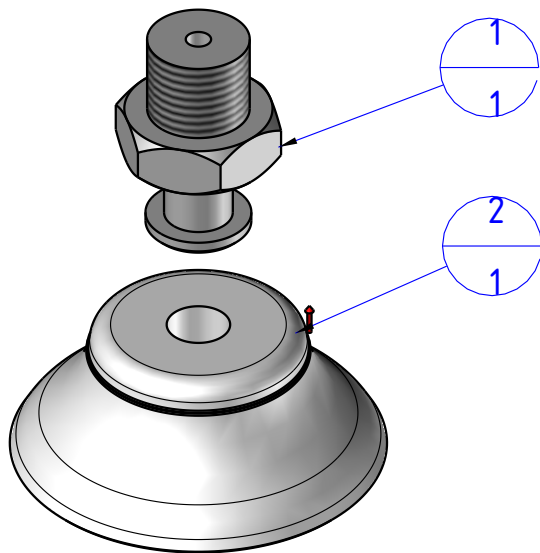
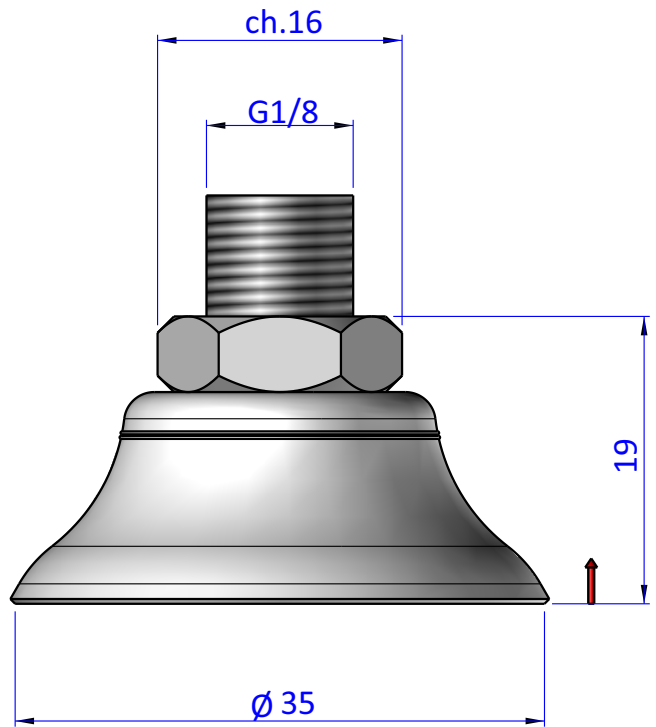

DESIGNED FROM FPS Automation		REVIEW A
DATE 18/11/2020	WEIGHT 0,012kg	
CODE KIT.08.28.D35		

Format **A4**
UNI 936-76

GENERAL TOLERANCE
UNI - ISO 2768
CLASSE **f**

DESCRIPTION
KIT.08.28.D35